

ADJ WORK-MATE STAND - MODEL: AHT-H-1936

APPROX WEIGHT: 46.91 lbs.
DOES NOT INCLUDE WEIGHT OF POWER OR PACKAGING!!!

*** ANY ADDITIONS, DELETIONS, OR OMISSIONS MUST BE CORRECTED ON THIS DRAWING AS THIS DRAWING WILL BE CONSIDERED ALL INCLUSIVE ***
ALL GRAPHICS PROVIDED ARE FOR REFERENCE ONLY. IF CERTAIN DIMENSIONS ARE CRITICAL PLEASE VERIFY THOSE DIMENSIONS WITH YOUR SALESPERSON

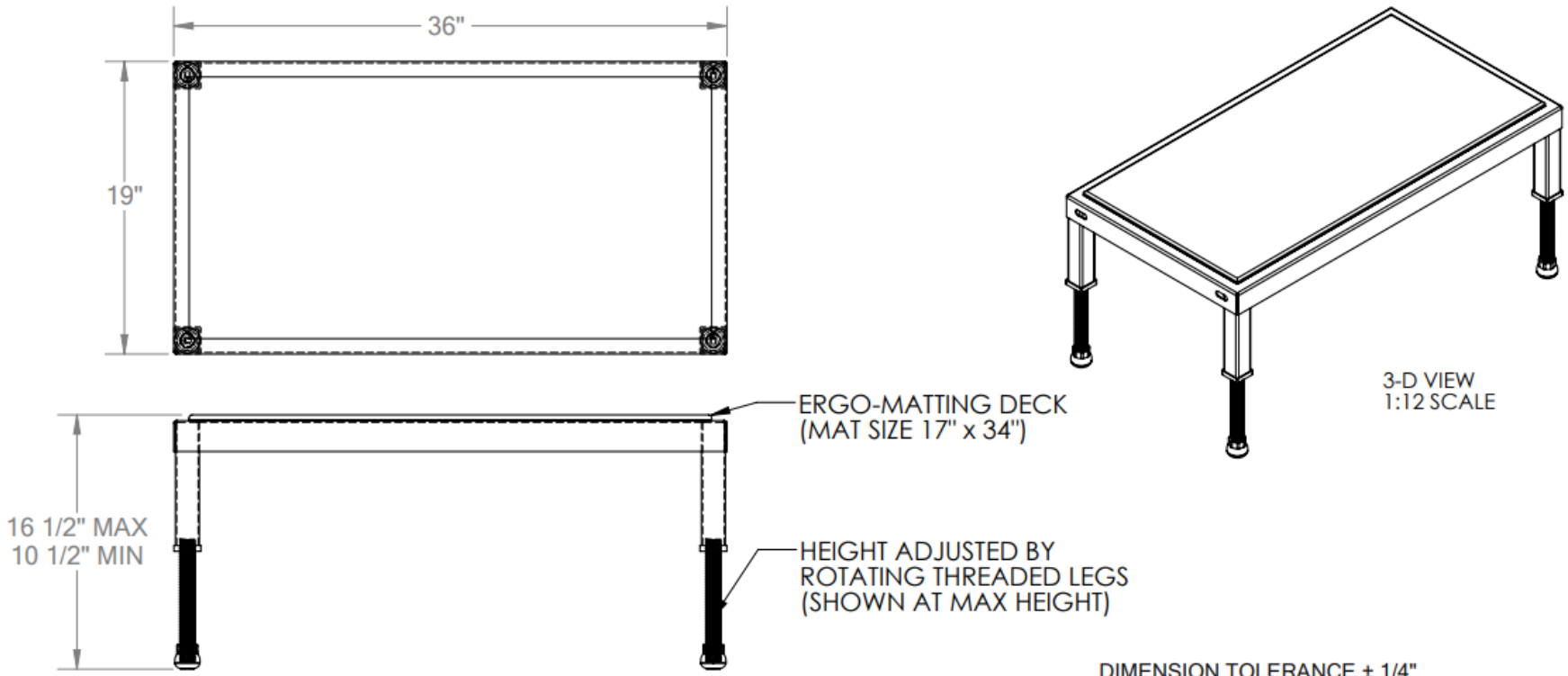

DIMENSION TOLERANCE ± 1/4"

STANDARD FEATURES
 MODEL NUMBER : AHT-H-1936
 CAPACITY: 500 LBS.
 DECK WIDTH: 19"
 DECK LENGTH: 36"
 RAISED HEIGHT: 16 1/2"
 LOWERED HEIGHT: 10 1/2"
 ALL STEEL CONSTRUCTION
 (ASTM A-36 MIN.)
 WITH WELDING TO MEET AWS.
 ERGO MATting IS BLUE
 TOUGH BAKED IN POWDER
 COATED YELLOW FINISH

SPECIAL FEATURES
 NONE

A P P R O V A L

I, THE UNDERSIGNED, AGREE THAT THE PRODUCT AS REPRESENTED SATISFIES DESIGN AND DIMENSION REQUIREMENTS. I ALSO ACKNOWLEDGE MY DUTY TO CONFIRM PRODUCT AND INSTALLATION COMPLIANCE WITH ALL APPLICABLE FEDERAL, STATE AND LOCAL REGULATIONS AND STANDARDS.
ANY MODIFIED UNITS ARE NON-RETURNABLE
 As drawn As marked

Signed: _____ Date: _____
 Printed Name: _____
LEAD TIME WILL START UPON RECEIPT OF SIGNED APPROVAL DRAWING

FOR INTERNAL USE ONLY PROJECT SIGN OFF	
SALES	
ENG.	
FAB.	
POWER	

DISTRIBUTOR'S NAME:		P.O.#
		X
		W.O.#
		X
DRAWN BY:	DATE:	SALES:
MTS	12/27/13	X
REFERENCE: X	SCALE: 1:10	FILE NAME:
QUOTED LEAD TIME: X	QUOTE #	14-007-206
	X	