

EDGE-O-DOCKLEVELER - PE-2066

APPROX WEIGHT: 489.61 lbs.
DOES NOT INCLUDE WEIGHT OF POWER OR PACKAGING!!!

*** ANY ADDITIONS, DELETIONS, OR OMISSIONS MUST BE CORRECTED ON THIS DRAWING AS THIS DRAWING WILL BE CONSIDERED ALL INCLUSIVE ***
ALL GRAPHICS PROVIDED ARE FOR REFERENCE ONLY. IF CERTAIN DIMENSIONS ARE CRITICAL PLEASE VERIFY THOSE DIMENSIONS WITH YOUR SALESPERSON

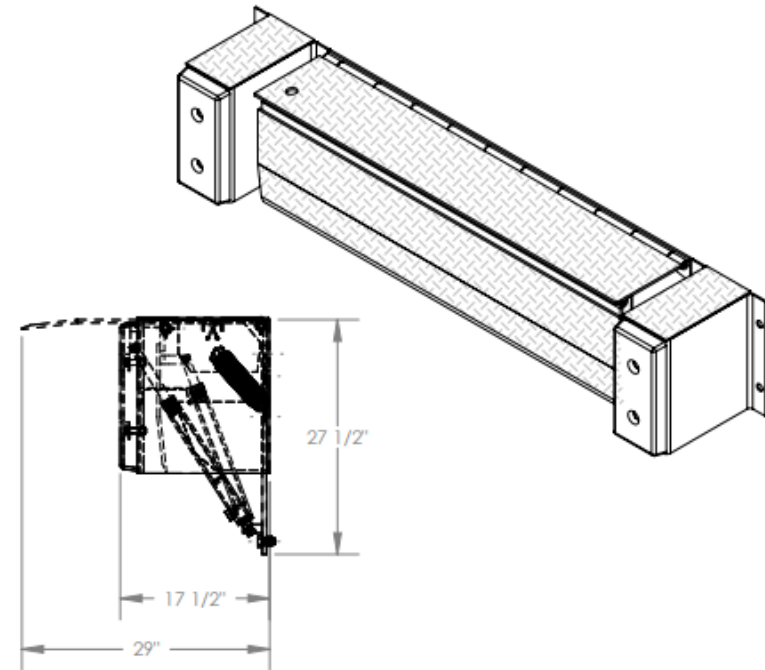
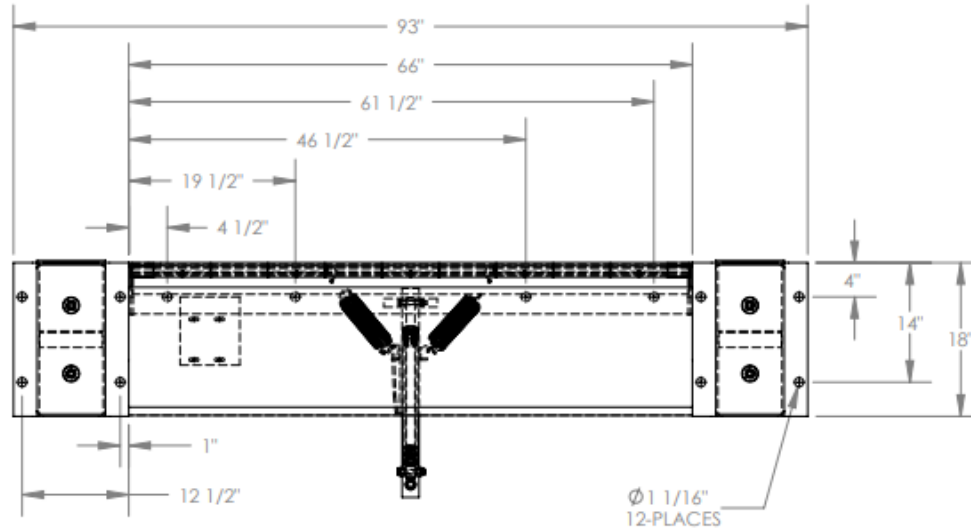

STANDARD FEATURES

- MODEL NUMBER IS PE-2066
- OVERALL WIDTH IS 93"
- DECK WIDTH IS 66"
- OVERALL DEPTH WITH RAMP OUT IS 29"
- BUMPER PROJECTION IS 17 1/2"
- UNIFORM CAPACITY IS 20,000 lbs.
- 5" ABOVE / 5" BELOW SERVICE RANGE
- RECOMMENDED FOR DOCKS AT LEAST 48" HIGH.
- UNIT COMES WITH MOTOR, PUMP, CONTROL BOX, CYLINDER, HYDRAULIC LINES AND OIL.
- TREADPLATE RAMP & DECK CONSTRUCTION

SPECIAL FEATURES

NONE

PLEASE CIRCLE SPECIFICATIONS:

POWER	AC	HAND-PUMP		
MOTOR VOLTAGE	115	208	230	460
DEDICATED CIRCUIT REQUIRED				
MOTOR PHASE	SINGLE	THREE		
CONTROL	HAND	* FOOT		

* AVAILABLE AT ADDITIONAL COST

DIMENSION TOLERANCE ± 1/4"

APPROVAL

I, THE UNDERSIGNED, AGREE THAT THE PRODUCT AS REPRESENTED SATISFIES DESIGN AND DIMENSION REQUIREMENTS. I ALSO ACKNOWLEDGE MY DUTY TO CONFIRM PRODUCT AND INSTALLATION COMPLIANCE WITH ALL APPLICABLE FEDERAL, STATE AND LOCAL REGULATIONS AND STANDARDS.

ANY MODIFIED UNITS ARE NON-RETURNABLE

As drawn As marked

Signed: _____ Date: _____

Printed Name: _____

LEAD TIME WILL START UPON RECEIPT OF SIGNED APPROVAL DRAWING

DISTRIBUTOR'S NAME:		P.O.#	X
		W.O.#	X
DRAWN BY:	M. WILSON	DATE:	1/2/2013
REFERENCE:	X	SCALE:	1:20
QUOTED LEAD TIME:	X	QUOTE #	X
		FILE NAME:	06-007-008